

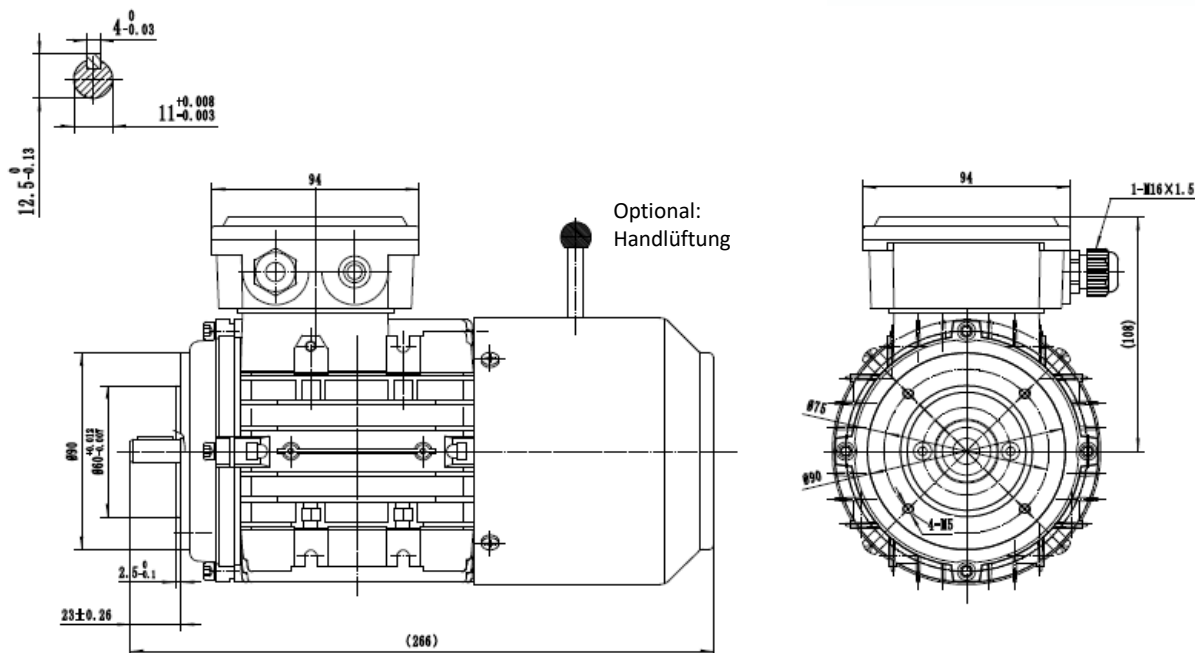

Drehstrombremsmotor / Three-Phase-Brakemotor
IE3 - 0,12 kW - 6 polig / 6 pole B14



Typ / type **SEV-BM3 632-6**

Gehäusematerial / frame material		Aluminum	Nenn Drehmoment / rated torque	1,32
Ausführung / execution		Dreiphasen/ three phase	Anzugs- zu Nennmoment / start- to rated torque	2,2
Baugröße / frame size		63	Kipp- zu Nennmoment / brakedown- to rated torque	2,1
Leistung / power @50Hz	kW	0,12	min. Dreh- zu Nennmoment / min- to rated torque	2
Nennstrom / rated current @230V	Δ	0,84	Anzugs- zu Nennstrom / starting- to rated current	2,8
Nennstrom / rated current @400V	Y	0,48	Lager / bearing (DE)	6201-2RZ
Drehzahl / speed @50Hz	(r/min)	870	Lager / bearing (NDE)	6201-2RZ
Wirkungsgrad / efficiency	IE3		Wellendichtung / shaft seal (DE/NDE)	12x22x5
	Eff. 100%	57,70	Hauptkabelverschraubung / main cable glands	1-M16*1.5
	Eff. 75%	54,00	Isolationsklasse / insulation class	F
	Eff. 50%	49,70	Schutzart / protection degree	IP 55
Leistungsfaktor / power factor cosφ	100% load	0,62	Thermischer Schutz / thermal protection	3*PTC
60Hz 265/460V	Power(kW)	0,14	Drehrichtung / rotation direction	rechts-links / clockwise-counterclockwise
60Hz 276/480V	Power(kW)	0,14	Einschaltdauer / service duty	S1
Drehzahl / speed @60Hz	(r/min)	1045	Wuchtung / balance	Halbkeilwuchtung / half-key balanced
Ausführung Bremse / execution brake		BLC457-06	Kühlungsart / cooling	IC 411
Bremsmoment / braking torque (@ 100 Upm / rpm)		4	Lautstärke / noise dB(A)	50
Normen / regulations		IEC / DIN / ISO / VDE / EN	Nettogewicht / net weight(kg)	5,99
Standard / standard		IEC 60034	Massenträgheitsmoment / moment of inertia (kg*m ²)	0,000521452
Umgebungstemperatur / ambient Temp.		-20°C ~ +40°C	Aufstellungshöhe / altitude (max.)	1000m über Meeresspiegel / above sea level