

IEC 34-30

Maßblatt Drehstrommotor / dimensions three phase motor IM B3 [mm]

Typ	A	AB	AC	B	BB	C	PM	ØD	DB	E	F	H	HD	K	L
SEV-160M-2	254	320	330	210	260	108	2-M40x1.5	42	M16	110	12	160	420	14,5	615

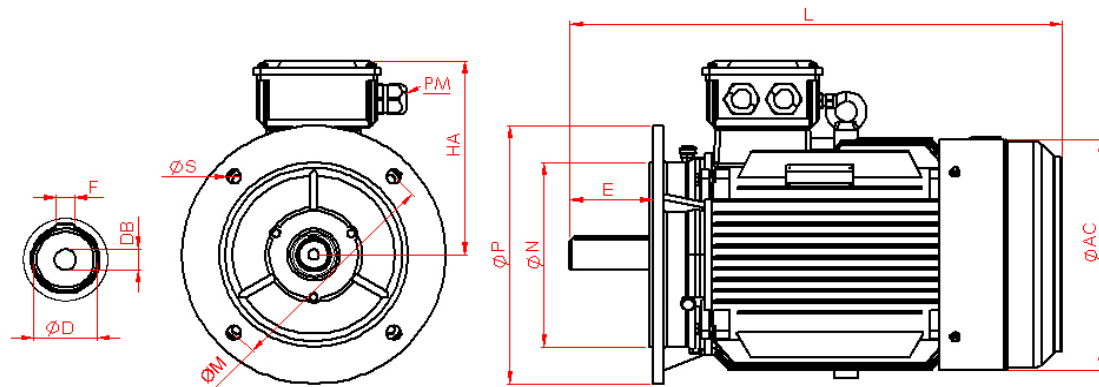

IE3

IEC 34-30

Maßblatt Drehstrommotor / dimensions three phase motor IM B5 [mm]

Typ	AC	ØD	DB	E	F	HA	PM	L	ØP	ØN	ØM	ØS
SEV-160M-2	330	42	M16	110	12	260	2-M40x1.5	615	350	250	300	19

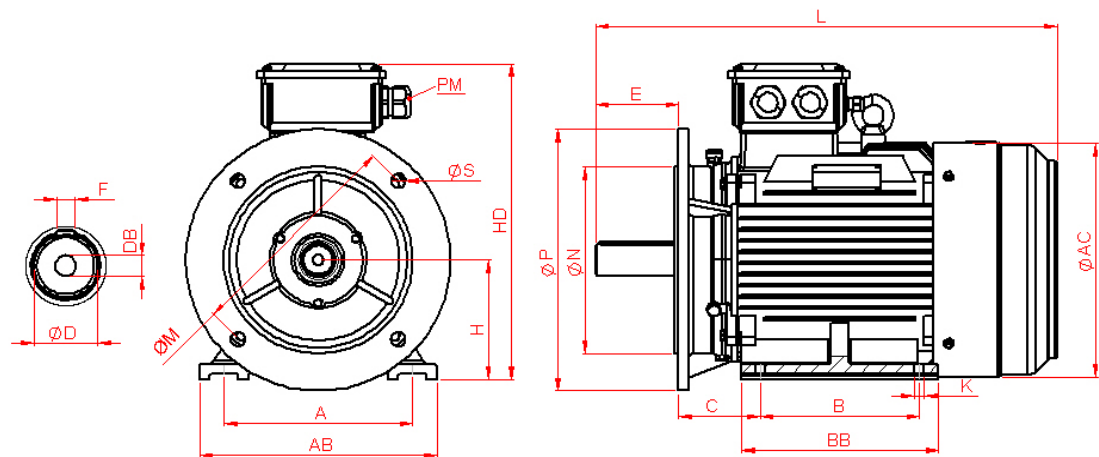

IE3

IEC 34-30

Maßblatt Drehstrommotor / dimensions three phase motor IM B35 [mm]

Typ	A	AB	AC	B	BB	C	PM	ØD	DB	E	F	H	HD	K	L
SEV-160M-2	254	320	330	210	260	108	2-M40x1.5	42	M16	110	12	160	420	14,5	615
											ØP	ØN	ØM	ØS	
											350	250	300	19	

technische Daten / technical data

Typ / type	SEV-160M-2				
Leistung / power	[kW]	11	Anzugs- zu Nennstrom / starting current	[Ia/In]	7,9
Drehzahl / speed	[upm]	2930	Kipp- zu Nennmoment / pull-out torque	[MK/Mn]	2,3
Anzahl der Pole/ number of poles		2	Anzugs- zu Nennmoment / starting torque	[Ma/Mn]	2,0
Nennstrom / rated current (400V)	[A]	19,95	Trägheitsmoment / moment of inertia	[Kgm ²]	0,04312
Leistungsfaktor / power factor	[cos φ]	0,89	Lager / bearing	[DE] [NDE]	6209 6209
Wirkungsgrad / efficiency	[100%] [75%] [50%]	91,2 91,2 90,2	max. Radialbelastung / max. radial force	[N]	1460
Schutzart / degree of protection	[IP]	IP55	Schallleistungspegel / noise level	[dB]	86
Drehmoment / torque	[Nm]	35,9	Umgebungstemperatur / ambient temperature	[°C]	-15°C/+40°C
Betriebsart / type of duty		S1	Gewicht / weight	[kg]	B3 = 112 B5 = 115 B35= 119
Iso.Kl		F	Aufstellungshöhe / altitude	[m]	≤1000m
max. Temperaturanstieg / temperature rise	[K]	<80K			
Frequenz / frequency	[Hz]	50/60 Hz			
Spannung / voltage		400/690 [Δ/Y] 50Hz 460/796 [Δ/Y] 60Hz			
Motorschutz / motor protection		3 x PTC Kaltleiter			
Herstellungsjahr / production year		siehe Seriennummer 1. vier Stellen see serial number 1. four digits			